

15" Projected capacitive Multi-Touch Monitor (Embedded)

Products application :

- POS Terminal
- Industrial PC
- Kiosk
- Gaming
- Medical apparatus
- Personal computer
- Mobile GPS
- Office automation
- Security system of the house
- Car-mounted amusement
- Military equipment
- Communicate

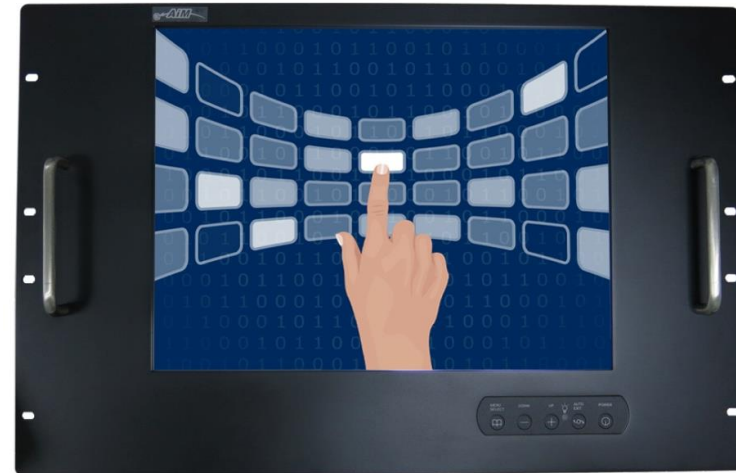

AIM-RMPCTU150-R31

Order information :

AIM-RMPCTU150-R31

AIM-RMPCTU150-R32

Touch interface :

USB (Multi-Touch*10)

RS232 (Single-Touch)

Mount type :

Embedded (7U Rack Mount)

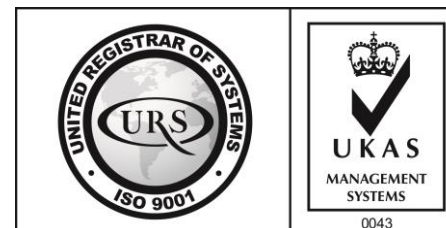

15" Projected capacitive Multi-Touch Monitor (Embedded)

Display Specifications :

Active Area	304 × 228 mm
Pixel Pitch	0.297 × 0.297 mm
Brightness	300 cd/m ²
Contrast Ratio	2000 : 1
Resolution	1024 x 768 (XGA)
Viewing Angle	L/R176° ; U/D176°
Response Time	23ms (Tr + Tf)
Display Colors	16.2M
Display Modes	640×480 ; 800×600 ; 1024×768
Signal input	VGA ; Audio ; DVI
Speaker	1W (8Ω) × 2
OSD Keyboard	⊙Power ⊙Auto adjust ⊕ ⊖ ⊙Menu
Power Source	DC 12V (DC Jack Φ2.1mm)
Power Consumption	≤14w
Storage 、 Operation	-30~70°C ; -20~70°C
VESA	75×75 ; 100×100 mm
Casing Colors	Black (OEM other colors)
Casing Size 、 Weight	482 × 310 × 53 mm ; 4.8 kg (W×H×D)
Carton 、 gross weight	550 × 395 × 170 mm ; 6.8 kg (W×H×D)
Accessory	VGA cable / Audio cable / AC100~240V Adapter / Power cable / USB or RS232 cable / Cleaning wipes / Driver Disk ※DVI cable (Optional)

※AiM Touch has the right to update specs without further notice.

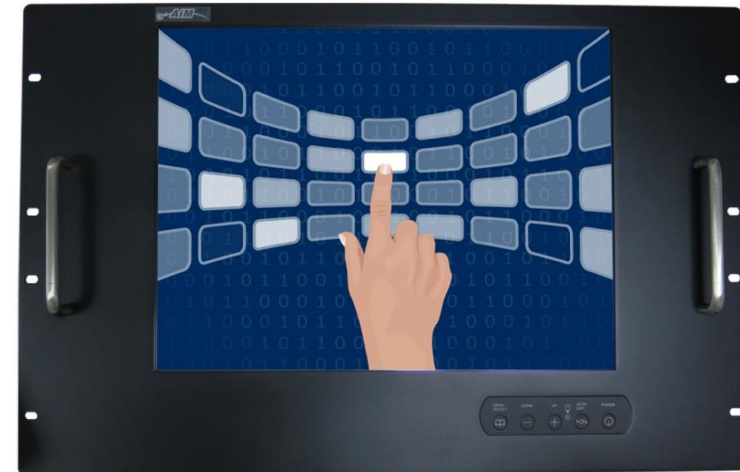

15" Projected capacitive Multi-Touch Monitor (Embedded)

Touch Feature :

Input Method	Capacitive stylus, Finger
Linearity	≤2.5mm
Surface	≥7H
Life Time	Unlimited
Application	Writing and Signature Capture Capability

Software Feature :

Draw Test	Position and linearity verification
Controller	Support multiple controllers
Languages	English · Simple Chinese · Traditional Chinese · Japanese · French · German · Spanish · Korean · Arabic · Czech · Danish · Dutch · Greek · Hungarian · Italian · Norwegian · Russian · Polish · Portuguese · Slovenian · Swedish · Thai · Turkish
Mouse Emulator	Right / left button emulation. Auto Right / left Click (PDA function)
Touch Style	Drawing a Mode · button a Mode · Touch Off/ on Switch
Double Click	Configurable double click speed · Configurable double click area
Sound Modes	No sound · Touch down · Touch up
Display Support	display rotation · Support multiple monitors
Division Pattern	Support two halves and four parts with touch function, you can also create your own division patterns.
Settings:	
Edge compensation	Support edge compensation and you can also add your own numbers for it.
Support O.S	All Windows-32/64bit O.S Android ; Linux ; MAC



3 Year Warranty
LCD Panel 1 Year

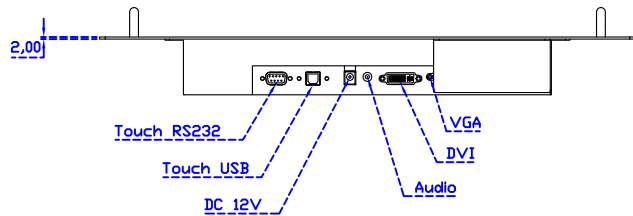
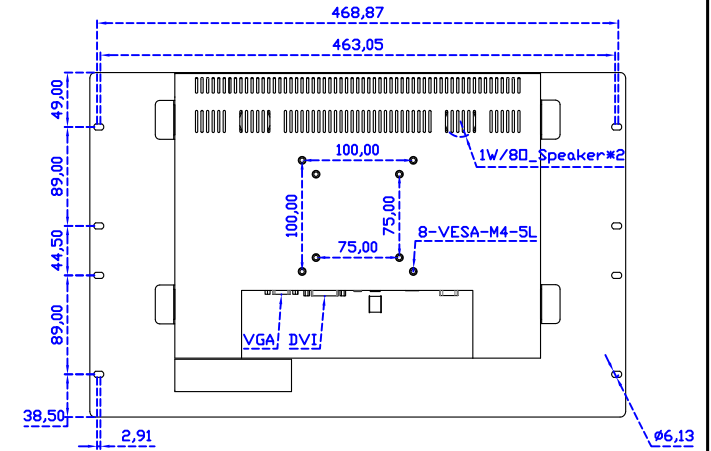
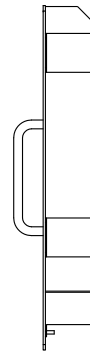
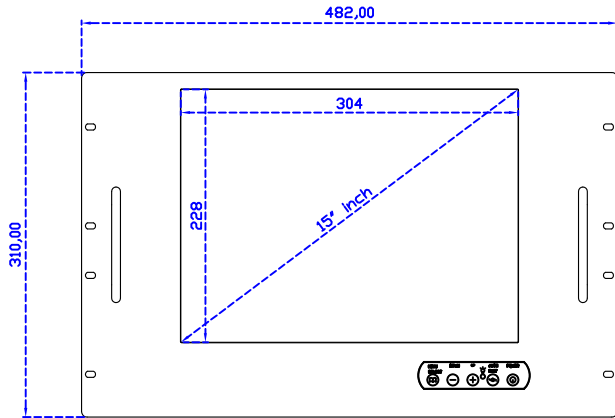
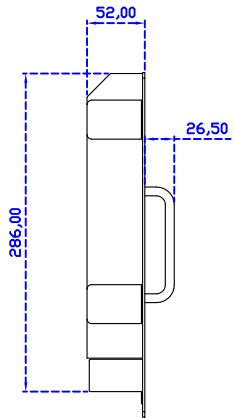
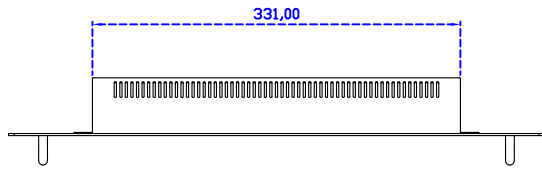

15" Embedded Touch Monitor.
(7U Rack Mount)

AIM-RMxxxx150-R31