

17.3" Resistive Single Touch Monitor (Embedded)

Products application :

- POS Terminal
- Industrial PC
- Kiosk
- Gaming
- Medical apparatus
- Personal computer
- Mobile GPS
- Office automation
- Security system of the house
- Car-mounted amusement
- Military equipment
- Communicate



AIM-PM5R173-R21W



AIM-TMOP5R173-R21W

Order information :

Touch interface :

Mount type :

AIM-PM5R173-R21W	USB	Embedded (Panel Mount)
AIM-PM5R173-R22W	RS232	
AIM-TMOP5R173-R21W	USB	Embedded (Open Frame)
AIM-TMOP5R173-R22W	RS232	

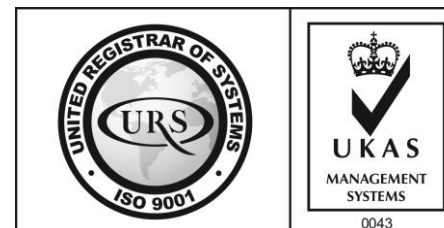

17.3" Resistive Single Touch Monitor (Embedded)

Display Specifications :

Active Area	381 × 214 mm
Pixel Pitch	0.1989 × 0.1989 mm
Brightness	300 cd/m ²
Contrast Ratio	700 : 1
Resolution	1920 x 1080 (Full HD)
Viewing Angle	L/R178° ; U/D178°
Response Time	25ms (Tr + Tf)
Display Colors	262K
Display Modes	800×600 ; 1024×768 ; 1280×720 ; 1280×800 ; 1280×1024 ; 1360×768 ; 1440×900 ; 1680×1050 ; 1920×1080
Signal input	VGA ; Audio ; DVI
Speaker	1W (8Ω) × 2
OSD Keyboard	⊙Power ⊙Auto adjust ⊕ ⊖ ⊙Menu
Power Source	DC 12V (DC Jack Φ2.1mm)
Power Consumption	≤12w
Storage 、 Operation	-20~60°C ; 0~50°C
VESA	75×75 ; 100×100 mm
Casing Colors	Black (OEM other colors)
Casing Size 、 Weight	【 PM 445×283×42 mm 3.2 kg 】；【 OP 441×279×36 mm 2.5 kg 】 (W×H×D)
Carton 、 gross weight	550 × 395 × 170 mm 【 PM 4.8 kg 】；【 OP 4 kg 】 (W×H×D)
Accessory	VGA cable / Audio cable / AC100~240V Adapter / Power cable / USB or RS232 cable / Touch pen / Cleaning wipes / Driver Disk ※DVI cable (Optional)

※AiM Touch has the right to update specs without further notice



AIM-PM5R173-R21W



17.3" Resistive Single Touch Monitor (Embedded)

Touch Feature :

Input Method	Finger, gloved hand, or stylus activation
Activation Force	≤50g
Linearity	≤1.5%
Surface	≥3H
Life Time	≥35,000,000
Application	Writing and Signature Capture Capability



Software Feature :

Calibration	Fast full oriental 4 points position
Compensation	Edge compensation. Accuracy 25 points linearity compensation
Draw Test	Position and linearity verification
Controller	Support multiple controllers
Languages	English · Simple Chinese · Traditional Chinese · Japanese · French · German · Spanish · Korean · Arabic · Czech · Danish · Dutch · Greek · Hungarian · Italian · Norwegian · Russian · Polish · Portuguese · Slovenian · Swedish · Thai · Turkish
Mouse Emulator	Right / left button emulation. Auto Right / left Click (PDA function)
Touch Style	Drawing a Mode · button a Mode · Touch Off/ on Switch
Double Click	Configurable double click speed · Configurable double click area
Sound Modes	No sound · Touch down · Touch up
COM Port Support	COM1 ~ COM255 for Windows and Linux COM1 ~ COM8 for MS- DOS
Display Support	display rotation · Support multiple monitors
Support O.S	All Windows-32/64bit O.S Android ; Linux ; MAC



AIM-TMOP5R173-R21W



3 Year Warranty
LCD Panel 1 Year

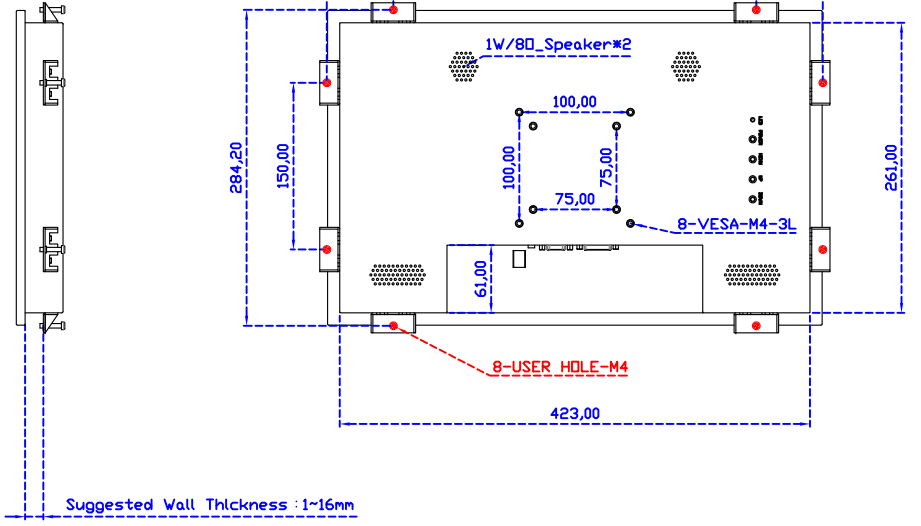
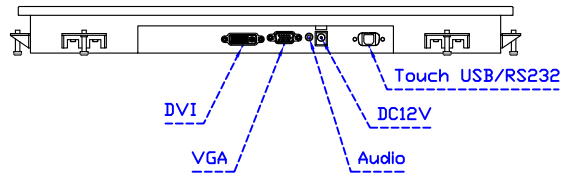
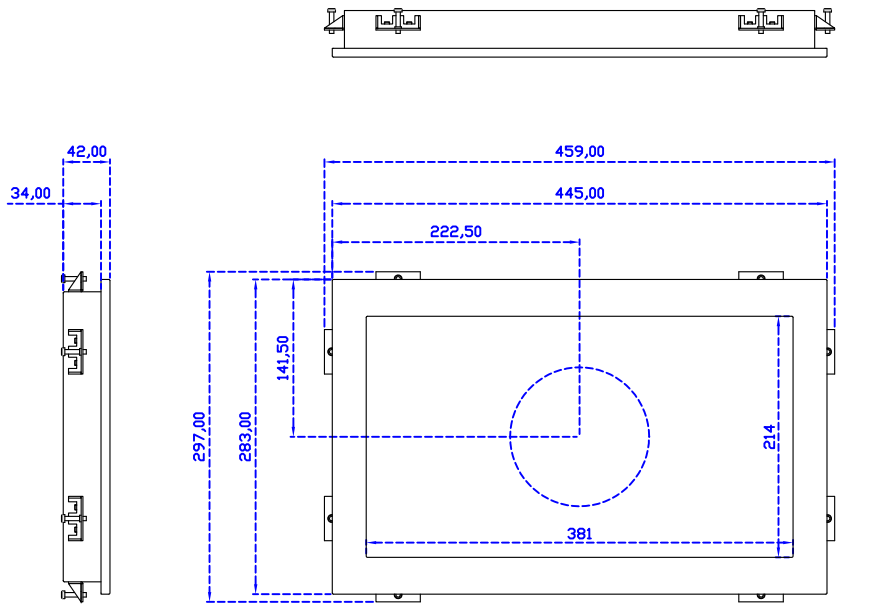

17.3" Embedded Touch Monitor.
(Panel Mount)

AIM-PMxxxx173-R21W

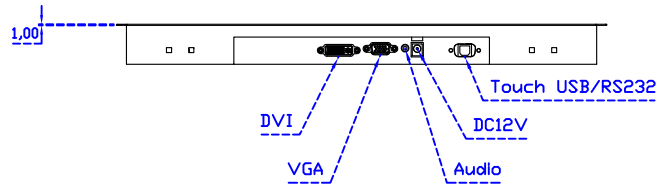
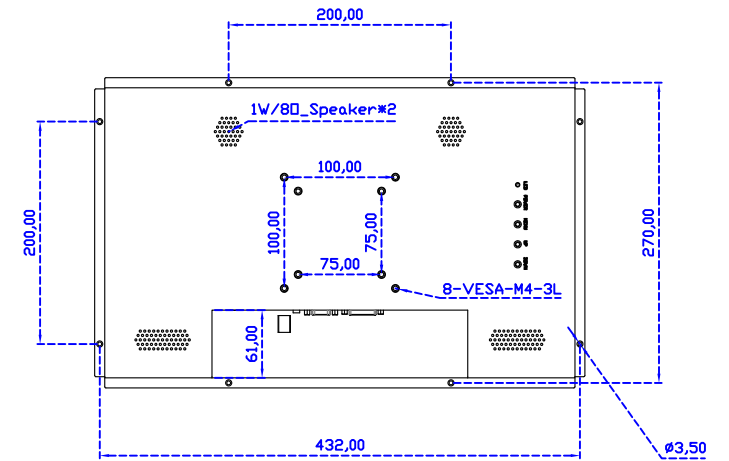
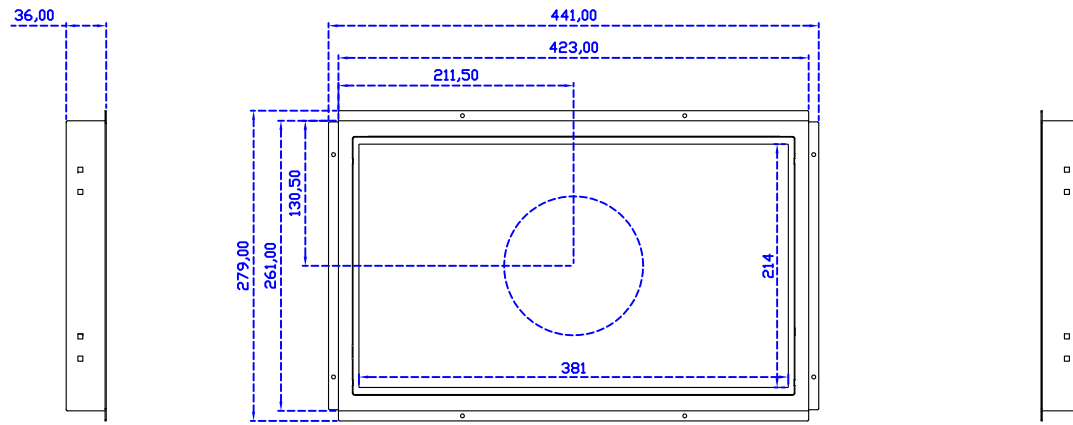

17.3" Embedded Touch Monitor.
(Open Frame)

AIM-TMOPxxxx173-R21W