

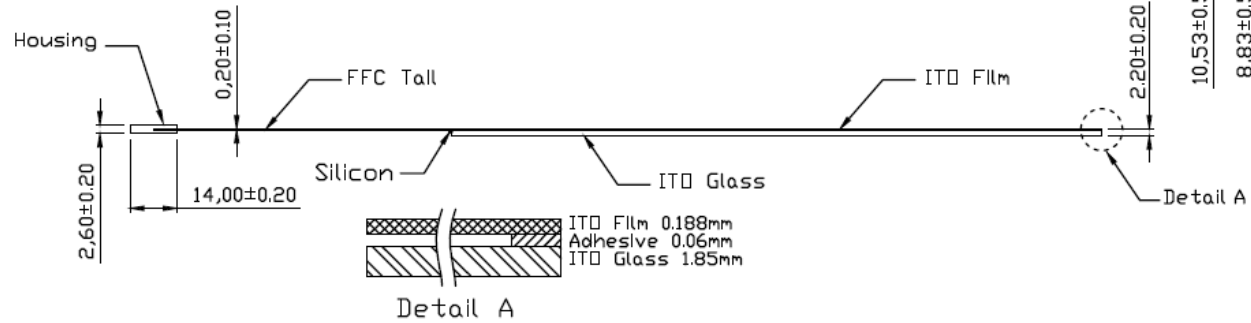

Connector Pinout	
Pin NO.	Designation
1	UR
2	LR
3	SG
4	UL
5	LL

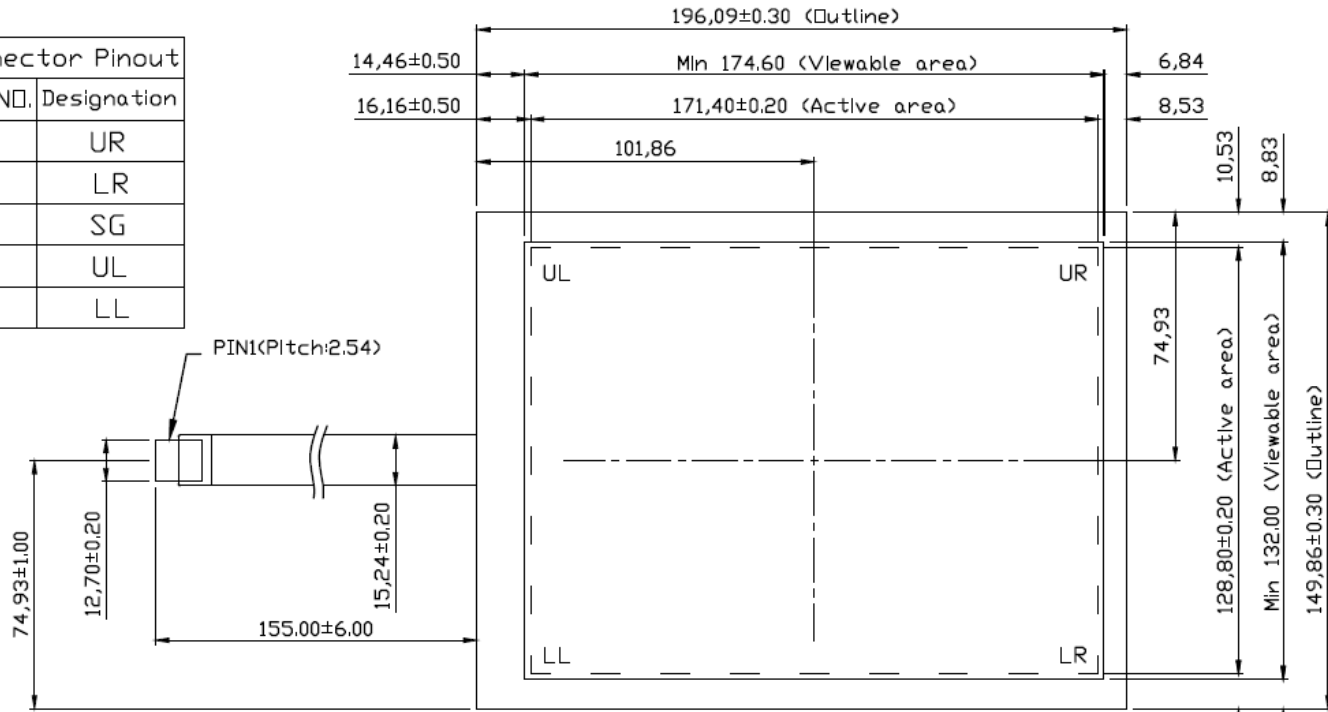

瞄準科技有限公司 AIM TOUCH TECHNOLOGY CO.,LTD.	DATE : 2013/05/15	Part Number	ITO Film Type	Glass Type	Glass Thickness	Finished Part Thickness
	MODEL :	AIM-5R-0840-M02-G1N	ANTI GLARE	high temperature strengthen	1.1mm	1.35mm±0.2
 WWW.AIMTOUCH.COM	AIM-5R-0840-M02	AIM-5R-0840-M02-G16N	ANTI GLARE	chemical strengthen	1.6mm	1.9mm±0.2
		AIM-5R-0840-M02-G2N	ANTI GLARE	high temperature strengthen	1.85mm	2.2mm±0.2

NOTE : All indications are the millimeters.